

# SUMITOMO

## SH210-6 SH210LC-6

- Engine Rated Power (Net): 117.3 kW·159.5 PS
- Operating Weight:
  - SH210-6 ..... 20,100 kg
  - SH210LC-6 ..... 20,400 kg
- Bucket: ISO/SAE/PCSA Heaped: 0.50~1.10 m<sup>3</sup>



# SUMITOMO



 **SUMITOMO (S.H.I.)  
CONSTRUCTION MACHINERY CO., LTD.**

731-1 Naganumahara-cho, Inage-ku, Chiba, 263-0001 Japan  
For further information please contact: Phone : +81-43-420-1829 Facsimile : +81-43-420-1907

We are constantly improving our products and therefore reserve the right to change designs and specifications without notice.  
Illustrations may include optional equipment and accessories and may not include all standard equipment.

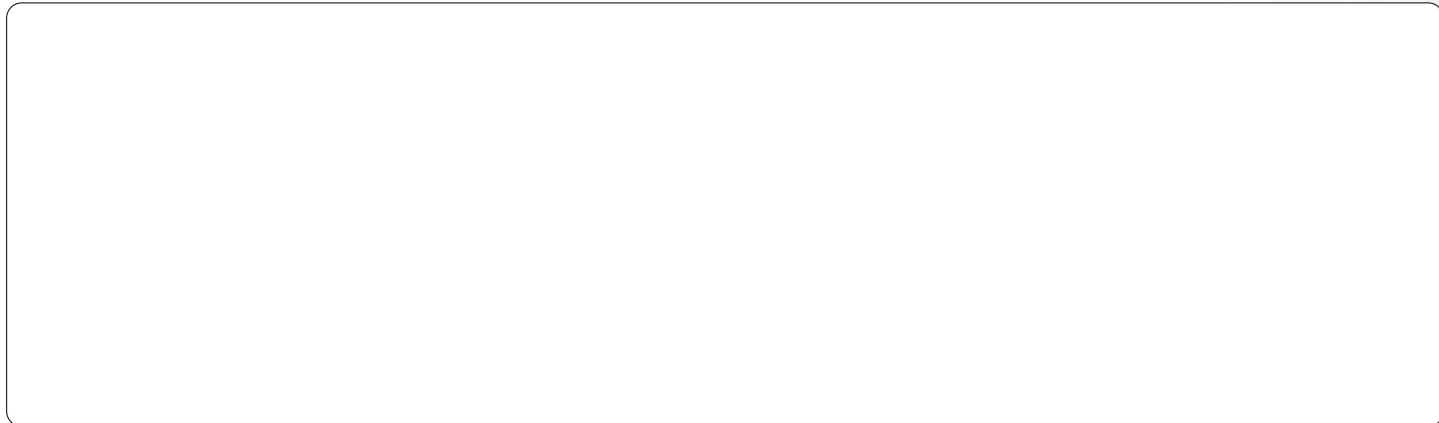

# *Performance Refined. Evolution Defined.*



## Engine and Hydraulics 04-07

- New Generation Engine System "SPACE 5+"
- New Hydraulic System "SIH:S+"
- SUMITOMO Fuel Efficiency Technology
- Dramatically Increased Productivity

## Durability and Maintenance 08-11

- High Rigidity Attachments
- EMS
- Ground Level Maintenance

## Safety and Operator Comfort 12-17

- Stylish and Spacious Cabin
- High-Definition Full Colour LCD Monitor

## Specifications 18-26

### ENGINEERED IN JAPAN

The world knows that Japanese designed and engineered products represent the highest quality, especially for Industrial Products. The hydraulic excavator is no exception when a totally integrated concept is required in design work involving key components, manufacturing engineering, and product quality assurance in the factory.

SUMITOMO hydraulic excavators are designed and manufactured today to meet the global demands of our many customers with the concept of Performance, Reliability, and Fuel Efficiency foremost in our minds. This proven Japanese technology and quality gives SUMITOMO excavator customers total peace of mind and provide a complete solution for the demands of the construction industry.



**Performance Refined.  
Evolution Defined.**



New Engine System **SPACE 5+ PLUS** + New Hydraulic System **SIH:S+ PLUS** = **14% Reduction in Fuel Consumption**  
(as compared with SH210-5 [H mode])

**New Generation Engine System "SPACE 5+"**

The new engine system optimises fuel efficiency and environmental performance via the advanced common rail fuel injection system, cooled EGR system, and turbocharger. At the same time, excellent response times are achieved.

**Engine and Hydraulics**



SH210-6 has achieved a 14% reduction in fuel consumption in comparison with our DASH 5 series, by fusing the new generation engine system "SPACE 5+" and the new hydraulic system "SIH:S+", further refining fuel efficiency. At the same time the newly developed ISUZU engine, contributes greatly to the environment.

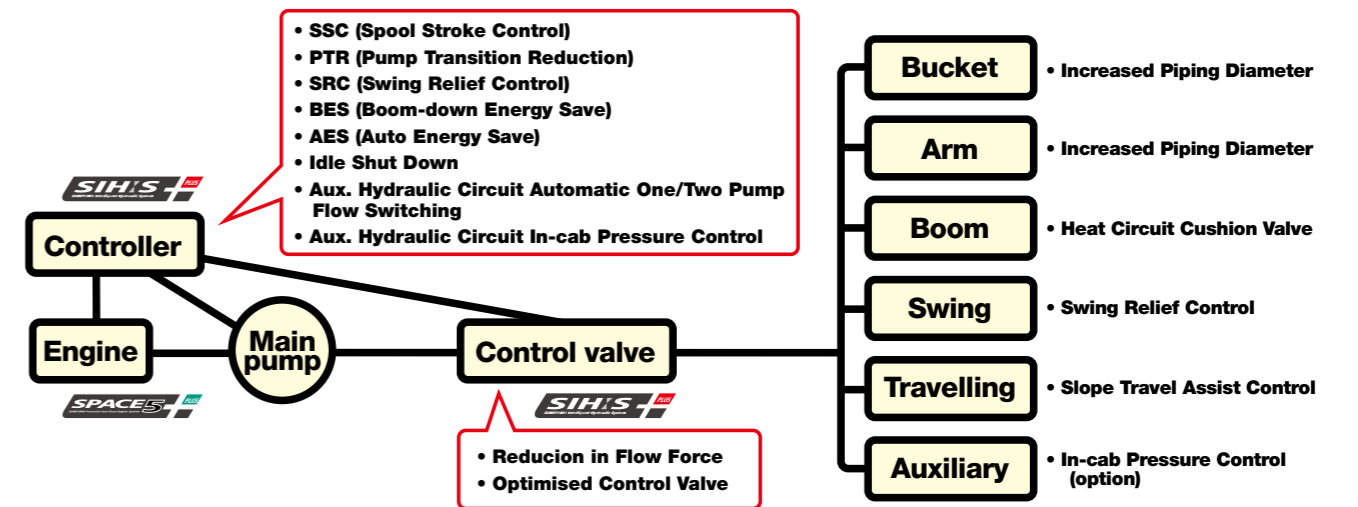

**Mode Selection by Throttle** (SUMITOMO UNIQUE DESIGN)

There are three working modes available: SP (Super Power) for heavy duty applications, H (Heavy) for normal working conditions, A (Auto) for a wide range of operations.



**Further Improvement of Fuel Consumption**

The new technology has improved operations and reduced fuel consumption on each working mode.

- SP mode **11% reduction in fuel consumption**
- H mode **14% reduction in fuel consumption**
- A mode **13% reduction in fuel consumption**  
(as compared with SH210-5)

\*Fuel consumption may vary from time to time depending on site and working conditions, operator skill and other circumstances.

**ECO Gauge Showing Low Energy Operation**

The energy saving conditions can be seen at a glance, as well as the fuel consumption indicator shown on the monitor.



**SUMITOMO Technology for Fuel Efficiency**

- **SSC (Spool Stroke Control)** (SUMITOMO UNIQUE DESIGN)  
Reduces engine load upon heavy duty operation.
- **BES (Boom-down Energy Save)** (SUMITOMO UNIQUE DESIGN)  
Lowers engine speed upon boom-down and swing operation which does not require large oil flow.
- **AES (Auto Energy Save)** (SUMITOMO UNIQUE DESIGN)  
Lowers engine speed accordingly when low engine load is sensed.
- **PTR (Pump Transition Reduction)**  
Decreases engine load when the pump flow requirement is reduced upon abrupt pump load.
- **Idle Shut Down & Auto Idle**

Upon activation, idle shut down automatically shuts the engine down when the machine is not in operation for set amount of time. Auto Idle is also available, which makes the engine begin idling approximately five seconds after the operation levers are in neutral position.





**Performance Refined.  
Evolution Defined.**

## Engine and Hydraulics



**SUMITOMO's original technology Spool Stroke Control (SSC), perfectly matches the engine and hydraulic power, and further improves the operational speed whilst maintaining smooth control of the machine.**

### Work Efficiency Drastically Increased

Spool Stroke Control (SSC) variably controls spool port flow rate, depending on the condition of operation. Improved power, speed, and smoother controls mean that work efficiency is dramatically increased.

### 4% Faster Cycle Time (SP mode)

Speed increase by 4% in cycle time has been achieved, giving further advance in productivity (as compared with 210-5 [SP mode]).

### Real Digging Power

The true digging force can not be expressed by a maximum digging power figure listed in sales brochures. With an improved hydraulic system and with a large arm cylinder, the arm-in motion speed slowdown is minimised. The digging power when combined with the attachment speed in motion convert to the operator's "Real Digging Power".

### Automatic Power Boost

The digging power increases automatically in quick response to the working conditions during heavy-duty digging work. This is a design unique to SUMITOMO, and continues for eight seconds (SP/H mode).

### Speed and Power, Dramatically Increases Productivity

• SP mode

**4% faster cycle time**

• H mode

**4% faster cycle time**

• A mode

**5% faster cycle time**  
(as compared with SH210-5)

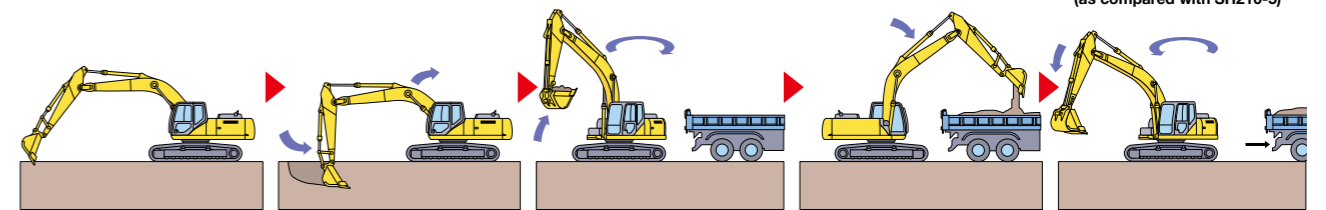

\*Based on SUMITOMO's testing condition and results.

### Operating Condition Easily Viewable on Display

Various control such as working modes and auxiliary hydraulic setting can be easily selected by the universally designed switch panel, and what's being selected can be easily viewed on the 7" wide monitor.





# Durability and Maintenance

## EMS (Easy Maintenance System) as Standard

SUMITOMO's EMS keeps the pins and bushes fully lubricated at all times and prevents rattling. This system significantly extends the service life of the pins and bushes.

The lubrication interval around the bucket is 250 hours, and for the other sections is 1,000 hours, keeping the joints lubricated for a long time and extending the service life of parts by reducing abrasion and rattling.

- **Bucket greasing interval: 250 hours**
- **Greasing interval for other sections: 1,000 hours**

\* The greasing interval depends on the working conditions.

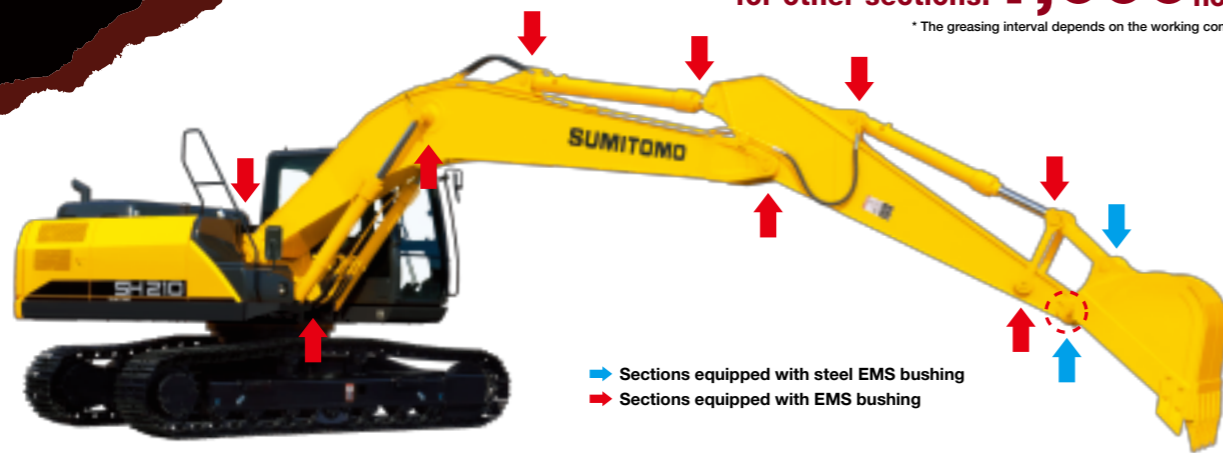

➡ Sections equipped with steel EMS bushing  
➡ Sections equipped with EMS bushing

### EMS bushing

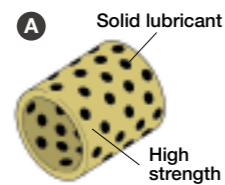

**A** A solid lubricant embedded in high strength brass forms a layer on the bushing surface to prevent contact between metals, maintaining an excellent lubricated state to reduce abrasion of joints.

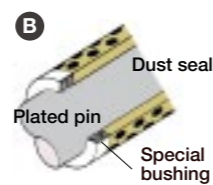

**B** The surface of the pin is plated to increase the surface hardness and improve the wear resistance accordingly.

### Steel EMS bushing



Steel EMS is installed around the bucket

- ① Grease is enclosed, however greasing is necessary every 1000 hours or six months depending on the level of dusting conditions.
- ② Greasing is also necessary after any components have been submerged underwater for prolonged periods.
- ③ Greasing is also recommended after use with hydraulic breakers, crushers or other high impact attachments such as Rock Saws etc.
- ④ Bucket pins should be cleaned thoroughly when removing or attaching new buckets.

Precautionary use of EMS

## High Rigidity Attachments

The structure of the boom and arm has been further improved, ensuring strength and durability. In addition, high strength castings are used for the boom base and arm end, improving reliability.

### • Boom

Thicker diaphragm and further welding penetration – More reliable

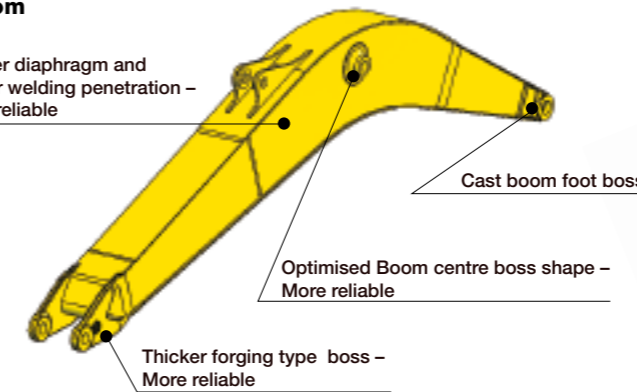

### • Arm

Forging arm foot boss with stress disperse welding structure

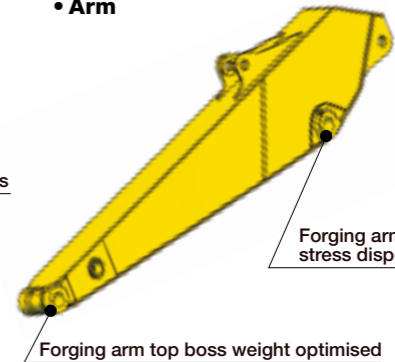

## Bucket

A one-piece wear plate covers the weld section to increase the wear life of the bucket.

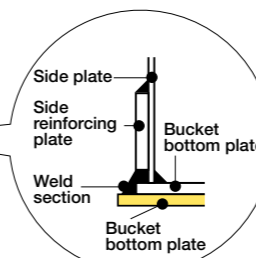
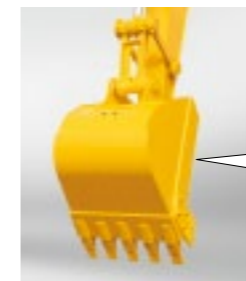

## High Rigidity Swing Frame

The swing frame has been strengthened to support the new ROPS cabin, as well as to increase durability.

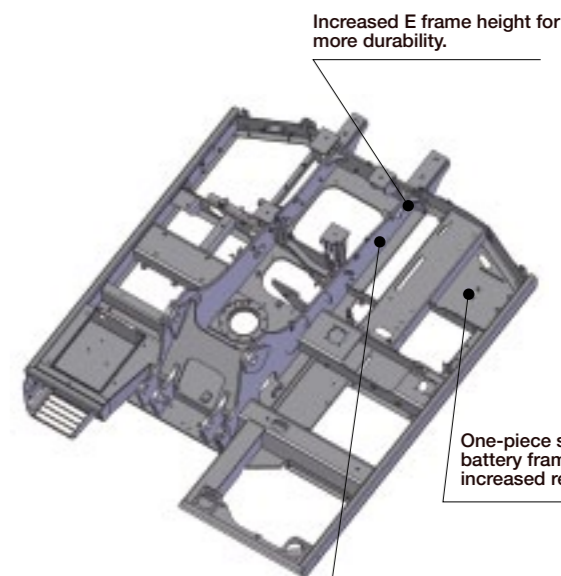

One-piece steel plate battery frame for increased reliability.

One-piece steel plate web for increased reliability.

## High Rigidity Undercarriage

For improved mobility, the track system has been strengthened ensuring longer wear life, performance, and improved reliability.

Increased durability with thicker motor case

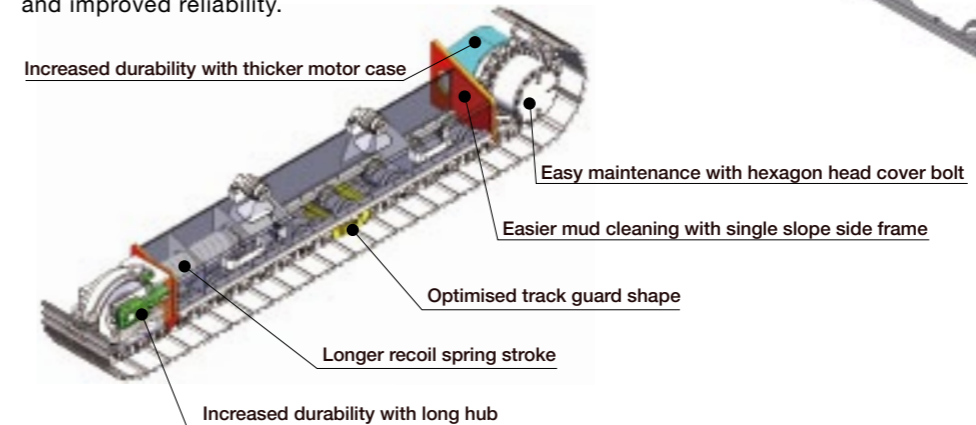

Easy maintenance with hexagon head cover bolt

Easier mud cleaning with single slope side frame

Optimised track guard shape

Longer recoil spring stroke

Increased durability with long hub



**Performance Refined.  
Evolution Defined.**

## Durability and Maintenance

Serviceability and durability are also important points of machine performance. Ground level access to the engine area makes daily maintenance extremely straightforward. Reliability has been further enhanced by increasing cooling capability and durability.

### Ground Level Access to Engine Area Improves Preventative Maintenance

Parts cleaning and maintenance are possible from the ground without climbing onto the upper structure of the excavator body.

#### • Increased Cooling Capability

With the larger radiator and oil cooler, cooling capacity is increased, thus improving reliability. In addition, cleaning of the dust-proof net is simplified.

#### • Easy Filter Replacement

A fuel prefilter and clogging sensor to the main fuel filter are provided as standard equipment to reduce trouble due to fuel clogging. In addition, the fuel and oil filters are installed at ground-accessible location to facilitate replacement.

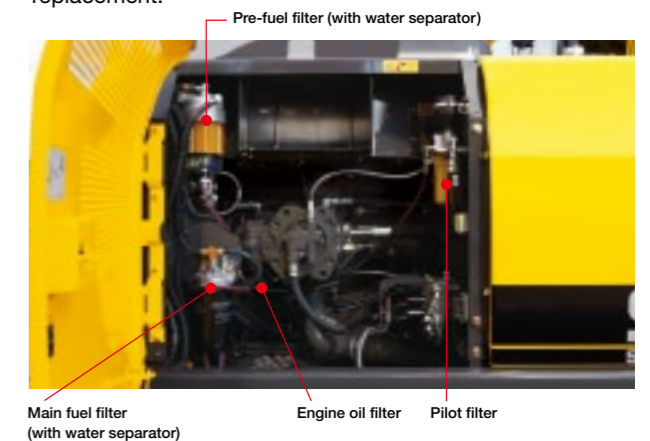
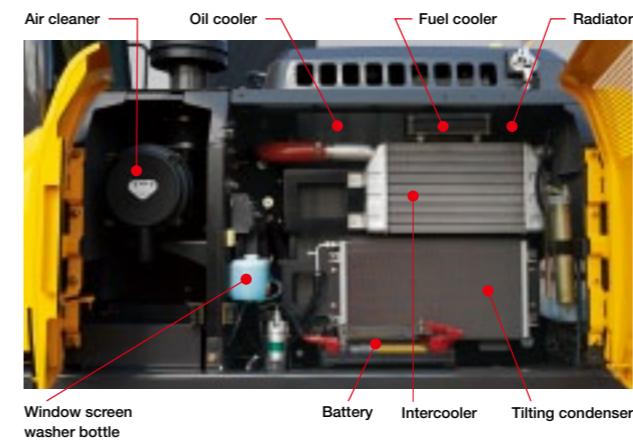

#### High-Performance Return Filter

The hydraulic oil change interval is 5,000 hours, and the return filter change interval is 2,000 hours. One high performance return filter keeps the same level of filtering as a nephron.



• Hydraulic oil change: **5,000** hours

• Life of filter: **2,000** hours

\* The oil and filter change interval varies by the working conditions.

#### Easy Access to A/C Filter

The air intake filter is located in a lockable compartment to make it easier to replace, and access to the inside cab filter has been simplified.



#### Fuse Box Location

The fuse box has been located in a separate compartment behind the seat, allowing easier access.



#### Cab Floor Mat **SUMITOMO** UNIQUE DESIGN

The washable floor mat has been redesigned for ease of removing and cleaning.



#### New Side Frame Shape

The cross-sectional shape has been redesigned to make cleaning easier.



**Performance Refined.  
Evolution Defined.**

## Safety and Operator Comfort

Planning for safety in the event of a roll accident, a new strengthened safety cabin has been provided. The reinforced cabin greatly increases the operator's safety.

### Newly Designed Strengthened Safety Cabin

The optimised design and strengthened parts increase the overall cabin strength. Even if the shovel were to tip over, the safety of the operator is ensured by keeping cabin deformation to a minimum.

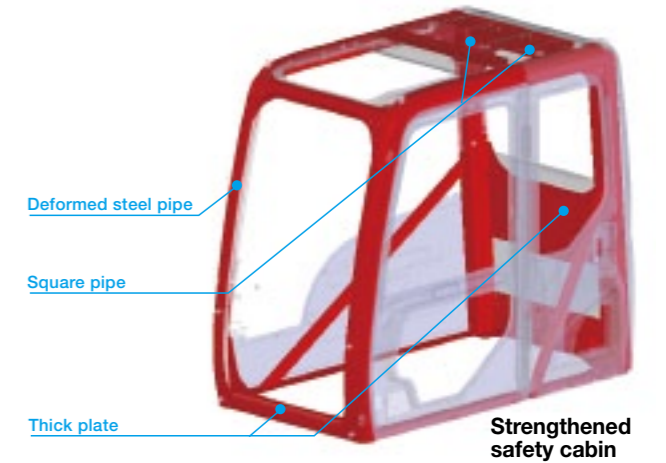

### Wide View Increases Safety of Work

In addition to the wide front view, the upper view has been widened to enhance work safety.



### Safe and Easy Entry into and Exit from the Cab

A large handrail for easy opening/closing of the door and increased floor space permit the operator to get in and out of the cab easily.



### New Cab Suspension Mounts

The new cab suspension mounts reduce vibration and impact transmitted to the cabin, and improve the operator's sitting quality and reduce operator fatigue. The sealed and pressurised cabin prevents entry of dust from outside.

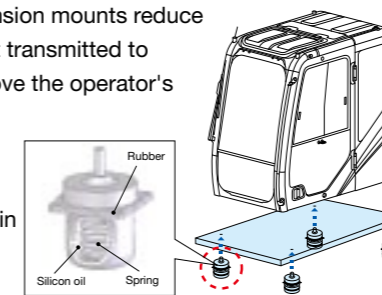

### New OPG Level 2 Head Guard (option)

OPG Level 2 head guard is available as an option. The see-through grille has been redesigned for better protection and visibility.



### Easy Access to the Upper Structure



New larger front-right step



Non-slip plate



ISO-compliant large handrail

### Cab Front Guard (option)

The optional cab front guard increases security from flying debris during wrecking work or the like.



**Performance Refined.  
Evolution Defined.**

## Safety and Operator Comfort

The spacious cab on suspension mounts and reclining suspension seat help reduce operator fatigue and provide a relaxed environment.

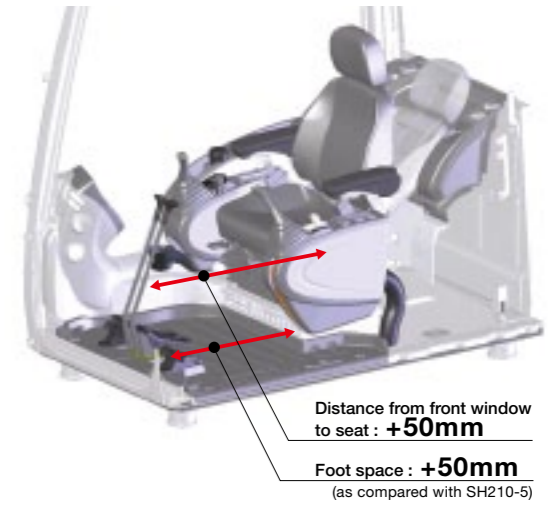

### Stylish and Spacious Cab

Wide cab space and floor space ensure more comfortable operation. In addition to the tilting console that is adjustable in four steps vertically, the increased sliding distance ensures optimum working conditions. Moreover, in cab noise level has been reduced by 2dB (as compared with SH210-5).

### Sophisticated Reclining Seat

The seat reclining system allows the operator to lay the seat flat and to rest on site without having to remove the headrest. The suspension seat eliminates vibration and fatigue. Air suspension is also available as option.

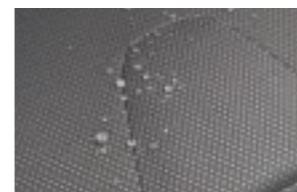

The highly water repellant seat covering is tough on dirt and water.



Air suspension (option)

### Auxiliary Operation Pedal

The auxiliary operation pedal is lighter to depress and the pedal angle is adjustable.



### Comfortable Equipment



Luggage space



Hot & cool box



Magazine rack

### Automatic Air Conditioner

Fully automatic climate control is available through the eight vents, with an 8% stronger A/C unit, and a 24% improvement in airflow. (as compared with SH210-5)



### Radio and Speaker with MP3 Jack

In addition to the AM/FM radio and dual speaker system with improved sound quality, auxiliary audio port is provided standard for devices such as MP3 players.



### Lever Switches

One-touch idle, horn, radio mute, or one-touch wiper buttons are installed on the operation levers in consideration of improved operability while working.

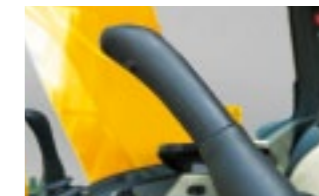

Radio mute switch (left lever)

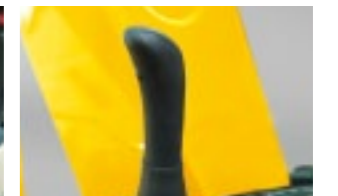

One-touch wiper switch (right lever)





# Safety and Operator Comfort

To support the operator in the field, the DASH 6 incorporates a 7" wide full colour LCD monitor with numerous functions and universally designed switch panel. The cabin with enhanced operator comfort ensures a safe working environment.

## Large High-Definition LCD Monitor

A new large high-definition full colour LCD monitor has been introduced with better visibility and a switch panel which is easy to operate. Added functionality such as ECO gauge showing parameter of energy saving, display of operation status and warning messages, provides accurate information which improves work efficiency and safety.

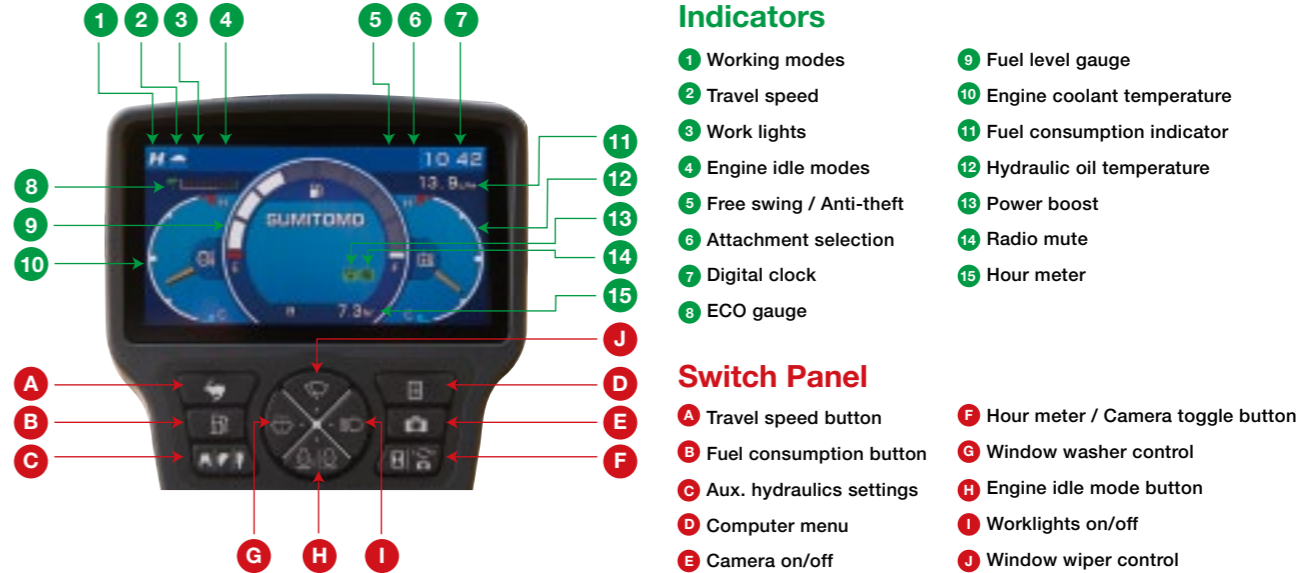

## Rearview Camera (option)

With the rearview camera, the operator can view the image on the large LCD monitor. A side camera is available as option and up to two different images can be displayed on the monitor.



## Rearview Mirror

The rearview mirrors reduce blind spots during operation. ISO compliant mirrors also available as option.



# Specifications

## SH210(LC) -6 Technical Data

Electronic-controlled engine of SPACE 5+ and SIH:S+ with New Hydraulic System Includes: three working modes (SP, H and A), one-touch/automatic idling system, automatic power-boost, speed assistance system, power-swing system.

### Engine

SH210(LC) -6	
Model	ISUZU GI-4HK1X
Type	Water-cooled, 4-cycle diesel, 4-cylinder in line, high pressure common rail system (electric control), Turbocharger with air cooled intercooler.
Rated output	117.3 kW (159.5 PS)/1,800 min <sup>-1</sup>
Maximum torque	606 N·m at 1,500 min <sup>-1</sup>
Piston displacement	5.19 ltr (5,193cc)
Bore and stroke	115 mm x 125 mm
Starting system	24 V electric motor starting
Alternator	24 V, 50 A
Fuel tank	410 ltr
Air filter	Double element

### Hydraulic pumps

Two variable displacement axial piston pumps provide power for boom/arm/bucket, swing, and travel. One gear pump for pilot controls.

SH210(LC) -6	
Maximum oil flow	2 x 211 ltr/min
Pilot pump max.oil flow	18 ltr/min

### Hydraulic motors

For travel: Two variable displacement axial piston motors.  
For swing: One fixed displacement axial piston motor.

### Relief valve settings

Boom/arm/bucket .....34.3 MPa (350 kgf/cm<sup>2</sup>)  
Boom/arm/bucket .....36.8 MPa (375 kgf/cm<sup>2</sup>) with auto power-up  
Swing circuit .....29.4 MPa (300 kgf/cm<sup>2</sup>)  
Travel circuit .....34.3 MPa (350 kgf/cm<sup>2</sup>)

### Control valve

With boom/arm holding valve  
One 4-spool valve for right track travel, bucket, boom and arm acceleration  
One 5-spool valve for left track travel, auxiliary, swing, boom acceleration and arm

### Oil filtration

Return filter ..... 6 microns  
Pilot filter ..... 8 microns  
Suction filter ..... 105 microns

### Hydraulic cylinders

Cylinder	Q'ty	Bore x Rod Diameter x Stroke
Boom	2	120 mm x 85 mm x 1255 mm
Arm	1	140 mm x 100 mm x 1460 mm
Bucket	1	120 mm x 85 mm x 1010 mm

Double-acting, bolt-up type cylinder tube-end; hardened steel bushings installed in cylinder tube and rods ends.

### Cabin & controls

The cabin is mounted on four fluid mountings. Features include safety glass front, rear and side windows, adjustable upholstered suspension seat with headrest and armrest, cigarette lighter, pop-up skylight window, and intermittent wiper with washer.  
Front window slides upward for storage and the lower front window is removable. Control levers are located in four positions tilting control consoles. Built-in type full-colour monitor display. Membrane switch on monitor display.

### Swing

Planetary reduction powered by axial piston motor. The internal ring gear with grease cavity for pinion. Swing bearing is single-row shear type ball bearing. Dual stage relief valves for smooth swing deceleration and stops. Mechanical disc swing brake.

SH210(LC) -6	
Swing speed	0~11.5 min <sup>-1</sup>
Tail swing radius	2,750 mm
Swing torque	64 kN·m (6,526 kgf·m)

### Undercarriage

X-style carbody is integrally welded for strength and durability. Grease cylinder track adjusters with shock absorbing springs. Undercarriage with lubricated rollers and idlers.

### Type of shoe: sealed link shoe

#### Upper rollers -

Heat treated, mounted on steel bushings with leaded tin bronze casting, sealed for lifetime lubrication.

#### Lower rollers -

Heat treated, mounted on steel bushings with leaded tin bronze casting, sealed for lifetime lubrication.

#### Track adjustment -

Idler axles adjusted with grease cylinder integral with each side frame; adjustment yoke mechanism fitted with heavy duty recoil spring.

### Number of rollers and shoes on each side

	SH210-6	SH210LC-6
Upper rollers	2	2
Lower rollers	7	8
Track shoes	46	49

### Travel system

Two-speed independent hydrostatic system with compact axial motors for increased performance. Hydraulic motor powered output shaft coupled to a planetary reduction unit and track sprocket. All hydraulic components mounted within the width of side frame.  
Travel speed can be selected by the switch panel on the monitor display. Hydraulically released disc parking brake is built into each motor.

SH210(LC) -6		
Travel speed	High	5.6 km/h
	Low	3.4 km/h
Drawbar pull		188 kN (19,171 kgf)

### Lubricant & coolant capacity

SH210(LC) -6	
Hydraulic system	240 ltr
Hydraulic oil tank	147 ltr
Fuel tank	410 ltr
Cooling system	30.8 ltr
Final drive case (per side)	5.0 ltr
Swing drive case	5.0 ltr
Engine crank case	23.1 ltr

### Auxiliary hydraulic system

SH210(LC) -6			
Auxiliary piping type (option)	For Breaker	For Double (breaker & crusher) acting	For D/A + Second option line
Arm type	STD	HD	HD
Bucket linkage type	HD	HD	HD
Auxiliary hydraulic pump flow	211 ltr/min	422 ltr/min	422+60 ltr/min

## Bucket

Options and specifications may differ depending on countries and regions

Model	SH210(LC) -6									
Bucket capacity (ISO/SAE/PCSA heaped)	0.5 m <sup>3</sup>	0.8 m <sup>3</sup>	0.9 m <sup>3</sup>	1.0 m <sup>3</sup>	1.1 m <sup>3</sup>					
Bucket capacity (CECE heaped)	0.44 m <sup>3</sup>	0.67 m <sup>3</sup>	0.78 m <sup>3</sup>	0.85 m <sup>3</sup>	0.93 m <sup>3</sup>					
Bucket type	STD	STD	STD Horizontal -pin	HD	HD Horizontal -pin	STD	STD Horizontal -pin	STD	STD Horizontal -pin	STD
Number of teeth	4	5	5	5	6	6	6	6	6	6
Width unit: mm	With side cutter		Without side cutter							
	830	1130	1136	1230	1360	1460				
	730	1030	1036	1130	1260	1360				
Weight unit: kg	514	645	630	727	685	665	737	807	771	
Combination	2.40 m arm	⊙(⊙)	⊙(⊙)	⊙(⊙)	●(⊙)	△(●)	△(△)	△(△)	△(△)	
	2.94 m arm	⊙(⊙)	●(⊙)	●(⊙)	○(●)	△(△)	△(△)	△(△)	△(△)	

⊙ Suitable for materials with density up to 2,000 kg/m<sup>3</sup> or less

● Standard bucket (Suitable for materials with density up to 1,800 kg/m<sup>3</sup> or less)

○ Suitable for materials with density up to 1,600 kg/m<sup>3</sup> or less

△ Suitable for loading

Figure in ( ) : LC type

## Weight & Ground Pressure

Model	SH210-6			
Shoe type	Shoe width	Overall width	Operating weight	Ground pressure
Triple grouser shoe	600 mm	2 800 mm	20 100 kg	45 kPa
	700 mm	2 900 mm	20 400 kg	39 kPa
	800 mm	3 000 mm	20 600 kg	35 kPa

Model	SH210LC-6			
Shoe type	Shoe width	Overall width	Operating weight	Ground pressure
Triple grouser shoe	600 mm	2 990 mm	20 400 kg	42 kPa
	700 mm	3 090 mm	20 900 kg	37 kPa
	800 mm	3 190 mm	21 200 kg	33 kPa

## Digging Force

Model	SH210(LC) -6		
Arm length	2.40 m (w/ power boost)	2.94 m (w/ power boost)	
Bucket digging force (with auto power up)	ISO 6015	142 kN (152 kN)	142 kN (152 kN)
	SAE: PCSA	127 kN (136 kN)	127 kN (136 kN)
Arm digging force (with auto power up)	ISO 6015	123 kN (132 kN)	103 kN (110 kN)
	SAE: PCSA	119 kN (127 kN)	100 kN (107 kN)

## Lifting Capacity

Notes: 1. Ratings are based on ISO 10567

- Lifting capacity does not exceed 75% of tipping load with the machine on firm, level ground or 87% full hydraulic capacity.
- The load point is a hook (not standard equipment) located on the back of the bucket.
- \*Indicates load limited by hydraulic capacity.
- 0 m = Ground.

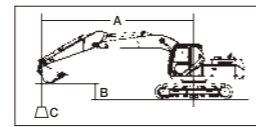

A: Radius of load  
B: Bucket hook height  
C: Lifting capacity



Unit: kg

### SH210-6

SHOE : 600 (mm)G  
BUCKET : SAE/PCSA 0.80 (m³)  
ARM LENGTH = 2.94 (m)  
MAXIMUM REACH = 9.90 (m)  
BOOM : 5.70 (m)

Bucket Hook Height	Max. Radius		9 m		8 m		7 m		6 m		5 m		4 m		3 m		2 m		1 m		Min. Radius					
	(kg)	(m)	(kg)	(m)	(kg)	(m)	(kg)	(m)	(kg)	(m)	(kg)	(m)	(kg)	(m)	(kg)	(m)	(kg)	(m)	(kg)	(m)	(kg)	(m)				
8 m	2 270*	7.33	2 270*	7.33																			2 660*	6.29	2 660*	6.29
7 m	2 150*	8.12	2 150*	8.12																						
6 m	2 090*	8.71	2 070	8.71																						
5 m	2 080*	9.12	1 850	9.12	2 590*	1 910	3 780	2 470	4 300*	3 190	4 390*	4 170														
4 m	2 100*	9.39	1 700	9.39	2 970	1 880	3 710	2 400	4 600*	3 080	5 120*	4 050	5 740*	5 410	6 010*	6 010*										
3 m	2 160*	9.54	1 610	9.54	2 920	1 830	3 620	2 320	4 570	2 970	5 780*	3 870	6 770*	5 230	8 470*	7 460	10 030*	10 030*								
2 m	2 240*	9.56	1 570	9.56	2 870	1 780	3 530	2 240	4 440	2 850	5 750	3 680	7 640*	4 920	10 140*	6 960	12 590*	10 970								
1 m	2 360*	9.48	1 570	9.48	2 820	1 740	3 450	2 160	4 320	2 730	5 550	3 510	7 480	4 650	10 890*	6 510	8 210*	8 210*								
0 m	2 530*	9.28	1 610	9.28	2 780	1 700	3 380	2 100	4 210	2 630	5 390	3 370	7 250	4 450	10 620	6 220	8 370*	8 370*	4 880*	4 880*						
-1 m	2 780	8.97	1 700	8.97																						
-2 m	3 020	8.54	1 850	8.54																						
-3 m	3 390	7.96	2 100	7.96																						
-4 m	3 980	7.23	2 480	7.23																						
-5 m	5 050	6.28	3 170	6.28																						
-6 m	5 960*	4.67	5 130	4.67																						

### SH210-6

SHOE : 600 (mm)G  
BUCKET : SAE/PCSA 0.90 (m³)  
ARM LENGTH = 2.40 (m)  
MAXIMUM REACH = 9.42 (m)  
BOOM : 5.70 (m)

Bucket Hook Height	Max. Radius		9 m		8 m		7 m		6 m		5 m		4 m		3 m		2 m		1 m		Min. Radius				
	(kg)	(m)	(kg)	(m)	(kg)	(m)	(kg)	(m)	(kg)	(m)	(kg)	(m)	(kg)	(m)	(kg)	(m)	(kg)	(m)	(kg)	(m)	(kg)	(m)			
8 m	3 390*	6.61	3 390*	6.61																					
7 m	3 190*	7.51	2 750	7.51																					
6 m	3 110*	8.14	2 310	8.14																					
5 m	3 080*	8.59	2 030	8.59																					
4 m	2 960	8.89	1 850	8.89																					
3 m	2 820	9.05	1 740	9.05	2 860	1 770	3 540	2 250	4 460	2 870	5 790	3 730	7 350*	5 020	8 650*	7 150									
2 m	2 770	9.08	1 700	9.08	2 820	1 730	3 460	2 170	4 340	2 750	5 600	3 560	7 580	4 740	10 090*	6 640									
1 m	2 780	8.99	1 700	8.99																					
0 m	2 880	8.78	1 760	8.78																					
-1 m	3 060	8.45	1 880	8.45																					
-2 m	3 370	7.97	2 060	7.97																					
-3 m	3 880	7.33	2 420	7.33																					
-4 m	4 780	6.49	2 990	6.49																					
-5 m	5 470*	5.36	4 130	5.36																					

### SH210-6

SHOE : 700 (mm)G  
BUCKET : SAE/PCSA 0.80 (m³)  
ARM LENGTH = 2.94 (m)  
MAXIMUM REACH = 9.90 (m)  
BOOM : 5.70 (m)

Bucket Hook Height	Max. Radius		9 m		8 m		7 m		6 m		5 m		4 m		3 m		2 m		1 m		Min. Radius				
	(kg)	(m)	(kg)	(m)	(kg)	(m)	(kg)	(m)	(kg)	(m)	(kg)	(m)	(kg)	(m)	(kg)	(m)	(kg)	(m)	(kg)	(m)	(kg)	(m)			
8 m	2 270*	7.33	2 270*	7.33																					
7 m	2 150*	8.12	2 150*	8.12																					
6 m	2 090*	8.71	2 090*	8.71																					
5 m	2 080*	9.12	1 880	9.12	2 590*	1 940	3 830	2 500	4 300*	3 230	4 390*	4 220													
4 m	2 100*	9.39	1 730	9.39	3 020	1 910	3 760	2 430	4 600*	3 130	5 120*	4 100	5 740*	5 470	6 010*	6 010*									
3 m	2 160*	9.54	1 640	9.54	2 970	1 870	3 680	2 360	4 640	3 010	5 780*	3 920	6 770*	5 300	8 470*	7 530	10 030*	10 030*							
2 m	2 240*	9.56	1 600	9.56	2 920	1 810	3 590	2 270	4 510	2 890	5 830	3 730	7 730	4 990	10 140*	7 050	12 590*	11 100							
1 m	2 360*	9.48	1 600	9.48	2 870	1 770	3 510	2 200	4 380	2 770	5 630	3 560	7 590	4 710	11 020	6 600	8 210*	8 210*							
0 m	2 530*	9.28	1 640	9.28	2 830	1 730	3 440	2 140	4 280	2 680	5 470	3 420	7 350	4 510	10 770	6 310	8 370*	8 370*	4 880*	4 880*					
-1 m	2 780*	8.97	1 730	8.97																					
-2 m	3 070	8.54	1 890	8.54																					
-3 m	3 450	7.96	2 130	7.96																					
-4 m	4 040	7.23	2 520	7.23																					
-5 m	5 130	6.28	3 220	6.28																					
-6 m	5 960*	4.67	5 200	4.67																					

Notes: 1. Ratings are based on ISO 10567

- Lifting capacity does not exceed 75% of tipping load with the machine on firm, level ground or 87% full hydraulic capacity.
- The load point is a hook (not standard equipment) located on the back of the bucket.
- \*Indicates load limited by hydraulic capacity.
- 0 m = Ground.

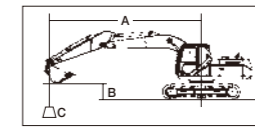

A: Radius of load  
B: Bucket hook height  
C: Lifting capacity



Unit: kg

### SH210-6

SHOE : 700 (mm)G  
BUCKET : SAE/PCSA 0.90 (m³)  
ARM LENGTH = 2.40 (m)  
MAXIMUM REACH = 9.42 (m)  
BOOM : 5.70 (m)

Bucket Hook Height	Max. Radius		9 m		8 m		7 m		6 m		5 m		4 m		3 m		2 m		1 m		Min. Radius			
	(kg)	(m)	(kg)	(m)	(kg)	(m)	(kg)	(m)	(kg)	(m)	(kg)	(m)	(kg)	(m)	(kg)	(m)	(kg)	(m)	(kg)	(m)	(kg)	(m)		
8 m	3 390*	6.61	3 390*	6.61																				
7 m	3 190*	7.51	2 790	7.51																				
6 m	3 110*	8.14	2 340	8.14																				
5 m	3 080*	8.59	2 060	8.59																				
4 m	3 010	8.89	1 880	8.89																				
3 m	2 870	9.05	1 780	9.05	2 900	1 800	3 600	2 280	4 530	2 910	5 860	3 780	7 350*	5 080	8 650*	7 240								
2 m	2 820	9.08	1 730	9.08	2 870	1 760	3 520	2 210	4 410	2 790	5 690	3 610</												

## Lifting Capacity

Notes: 1. Ratings are based on ISO 10567

- Lifting capacity does not exceed 75% of tipping load with the machine on firm, level ground or 87% full hydraulic capacity.
- The load point is a hook (not standard equipment) located on the back of the bucket.
- \*Indicates load limited by hydraulic capacity.
- 0 m = Ground.

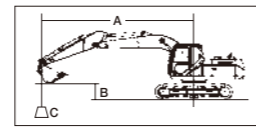

A: Radius of load  
B: Bucket hook height  
C: Lifting capacity



Unit: kg

### SH210LC-6

SHOE : 600 (mm)G  
BUCKET : SAE/PCSA 0.90 (m³)  
ARM LENGTH = 2.94 (m)  
MAXIMUM REACH = 9.90 (m)  
BOOM : 5.70 (m)

Bucket Hook Height	Max. Radius		Radius of Load																Min. Radius						
	(kg)	(m)	9 m	8 m	7 m	6 m	5 m	4 m	3 m	2 m	1 m	(kg)		(m)		(kg)	(m)	(kg)	(m)						
8 m	2 250*	7.29	2 250*	7.29																2 670*	6.24	2 670*	6.24		
7 m	2 120*	8.10	2 120*	8.10																3 680*	6.20	3 680*	6.20		
6 m	2 060*	8.69	2 060*	8.69																4 080*	6.11	4 080*	6.11		
5 m	2 050*	9.11	2 050*	9.11	2 510*	2 130	3 970*	2 730	4 300*	3 510	4 390*	4 390*								4 440*	5.67	4 440*	5.67		
4 m	2 070*	9.38	1 910	9.38	3 360	2 100	4 180*	2 660	4 590*	3 400	5 050*	4 450	5 700*	5 700*	6 150*	6 150*				5 340*	3.57	5 340*	3.57		
3 m	2 120*	9.53	1 810	9.53	3 320	2 050	4 090	2 580	5 090*	3 270	5 750*	4 260	6 770*	5 760	8 540*	8 120	10 310*	10 310*		8 120*	2.23	8 120*	2.23		
2 m	2 210*	9.56	1 760	9.56	3 260	2 000	4 000	2 490	5 020	3 150	6 410	4 070	7 790*	5 450	10 230*	7 760	11 000*	11 000*		4 850*	2.53	4 850*	2.53		
1 m	2 330*	9.48	1 770	9.48	3 210	1 950	3 920	2 410	4 890	3 030	6 310	3 890	8 490	5 180	11 210*	7 310	7 690*	7 690*		3 690*	2.39	3 690*	2.39		
0 m	2 500*	9.28	1 810	9.28	3 170	1 920	3 850	2 350	4 780	2 940	6 160	3 760	8 350	4 980	11 740*	7 030	8 150*	8 150*	4 460*	4 460*	3 660*	1.72	3 660*	1.72	
-1 m	2 750*	8.97	1 920	8.97			3 810	2 310	4 710	2 870	6 050	3 660	8 210	4 860	11 980*	6 930	9 600*	9 600*	6 830*	6 830*	5 440*	0.62	4 170*	0.62	
-2 m	3 120*	8.52	2 100	8.52			3 810	2 320	4 700	2 860	6 020	3 640	8 180	4 850	11 880*	6 950	11 680*	11 140	8 540*	8 540*	7 820*	0.41	6 000*	0.41	
-3 m	3 680*	7.92	2 380	7.92					4 750	2 900	6 060	3 680	8 220	4 890	11 520*	7 030	14 510*	11 710	10 750*	10 750*	9 170*	0.48	7 920*	0.48	
-4 m	4 630	7.14	2 850	7.14					4 830	2 990	6 160	3 790	8 260	5 000	10 760*	7 160	14 020*	11 900	15 110*	11 310*	11 310*	10 620*	0.84	10 620*	0.84
-5 m	5 240*	6.12	3 710	6.12							5 690*	3 890	7 430*	5 210	9 390*	7 390	12 100*	11 870	16 650*	16 650*		1.63	15 800*	1.63	

### SH210LC-6

SHOE : 600 (mm)G  
BUCKET : SAE/PCSA 1.00 (m³)  
ARM LENGTH = 2.40 (m)  
MAXIMUM REACH = 9.42 (m)  
BOOM : 5.70 (m)

Bucket Hook Height	Max. Radius		Radius of Load																Min. Radius				
	(kg)	(m)	9 m	8 m	7 m	6 m	5 m	4 m	3 m	2 m	1 m	(kg)		(m)		(kg)	(m)	(kg)	(m)				
8 m	3 340*	6.61	3 340*	6.61																3 070*	5.91	3 070*	5.91
7 m	3 150*	7.51	3 030	7.51																3 400*	5.73	3 400*	5.73
6 m	3 070*	8.14	2 550	8.14																4 520*	5.61	4 520*	5.61
5 m	3 040*	8.59	2 250	8.59																4 740*	4.79	4 740*	4.79
4 m	3 060*	8.89	2 060	8.89																7 980*	3.42	7 980*	3.42
3 m	3 140*	9.05	1 950	9.05	3 240	1 980	4 010	2 500	5 060	3 180	6 100*	4 130	7 310*	5 580	8 610*	8 010				6 330*	3.00	6 330*	3.00
2 m	3 140	9.08	1 900	9.08	3 200	1 940	3 930	2 420	4 930	3 060	6 370	3 960	8 240*	5 290	10 050*	7 480				5 980*	3.23	5 980*	3.23
1 m	3 170	8.99	1 910	8.99																6 280*	3.12	6 280*	3.12
0 m	3 270	8.78	1 970	8.78																5 650*	2.64	5 650*	2.64
-1 m	3 480	8.45	2 100	8.45																5 760*	1.50	5 760*	1.50
-2 m	3 830	7.97	2 330	7.97																6 680*	0.95	6 680*	0.95
-3 m	4 420	7.33	2 700	7.33																9 650*	1.03	9 650*	1.03
-4 m	5 340*	6.49	3 340	6.49																14 060*	1.47	14 060*	1.47
-5 m	5 430*	5.36	4 610	5.36																11 820*	2.55	11 820*	2.55

### SH210LC-6

SHOE : 700 (mm)G  
BUCKET : SAE/PCSA 0.90 (m³)  
ARM LENGTH = 2.94 (m)  
MAXIMUM REACH = 9.90 (m)  
BOOM : 5.70 (m)

Bucket Hook Height	Max. Radius		Radius of Load																Min. Radius					
	(kg)	(m)	9 m	8 m	7 m	6 m	5 m	4 m	3 m	2 m	1 m	(kg)		(m)		(kg)	(m)	(kg)	(m)					
8 m	2 250*	7.29	2 250*	7.29																2 670*	6.24	2 670*	6.24	
7 m	2 120*	8.10	2 120*	8.10																3 680*	6.20	3 680*	6.20	
6 m	2 060*	8.69	2 060*	8.69																4 080*	6.11	4 080*	6.11	
5 m	2 050*	9.11	2 050*	9.11	2 510*	2 180	3 970*	2 790	4 300*	3 590	4 390*	4 390*								4 440*	5.67	4 440*	5.67	
4 m	2 070*	9.38	1 960	9.38	3 450	2 150	4 250	2 720	4 590*	3 480	5 050*	4 540	5 700*	5 700*	6 150*	6 150*				5 340*	3.57	5 340*	3.57	
3 m	2 120*	9.53	1 860	9.53	3 400	2 110	4 190	2 640	5 090*	3 350	5 750*	4 350	6 770*	5 880	8 540*	8 250*	10 310*	10 310*		8 120*	2.23	8 120*	2.23	
2 m	2 210*	9.56	1 820	9.56	3 350	2 050	4 100	2 560	5 140	3 220	6 410*	4 160	7 790*	5 570	10 230*	7 920	11 000*	11 000*		4 850*	2.53	4 850*	2.53	
1 m	2 330*	9.48	1 820	9.48	3 290	2 010	4 020	2 480	5 010	3 110	6 460	3 990	8 600*	5 290	11 210*	7 470	7 690*	7 690*		3 690*	2.39	3 690*	2.39	
0 m	2 500*	9.28	1 870	9.28	3 260	1 970	3 950	2 420	4 900	3 010	6 300	3 850	8 540	5 090	11 740*	7 190	8 150*	8 150*	4 460*	4 460*	3 660*	1.72	3 660*	1.72
-1 m	2 750*	8.97	1 970	8.97																5 440*	0.62	4 170*	0.62	
-2 m	3 120*	8.52	2 160	8.52																5 440*	0.62	4 170*	0.62	
-3 m	3 680*	7.92	2 450	7.92																6 000*	0.41	6 000*	0.41	
-4 m	4 640*	7.14	2 920	7.14																6 000*	0.41	6 000*	0.41	
-5 m	5 240*	6.12	3 790	6.12																15 800*	1.63	15 800*	1.63	

Notes: 1. Ratings are based on ISO 10567

- Lifting capacity does not exceed 75% of tipping load with the machine on firm, level ground or 87% full hydraulic capacity.
- The load point is a hook (not standard equipment) located on the back of the bucket.
- \*Indicates load limited by hydraulic capacity.
- 0 m = Ground.

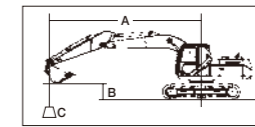

A: Radius of load  
B: Bucket hook height  
C: Lifting capacity



Unit: kg

### SH210LC-6

SHOE : 700 (mm)G  
BUCKET : SAE/PCSA 1.00 (m³)  
ARM LENGTH = 2.40 (m)  
MAXIMUM REACH = 9.42 (m)  
BOOM : 5.70 (m)

Bucket Hook Height	Max. Radius		Radius of Load																Min. Radius				
	(kg)	(m)	9 m	8 m	7 m	6 m	5 m	4 m	3 m	2 m	1 m	(kg)		(m)		(kg)	(m)	(kg)	(m)				
8 m	3 340*	6.61	3 340*	6.61																3 070*	5.91	3 070*	5.91
7 m	3 150*	7.51	3 100	7.51																3 400*	5.73	3 400*	5.73
6 m	3 070*	8.14	2 610	8.14																4 520*	5.61	4 520*	5.61
5 m	3 040*	8.59	2 310	8.59																4 740*	4.79	4 740*	4.79
4 m	3 060*	8.89	2 120	8.89																7 980*	3.42	7 980*	3.42
3 m	3 140*	9.05	2 010	9.05	3 320	2 030	4 110	2 560	5 160	3 250	6 100*	4 220	7 310*	5 690	8 610*	8 1							

## Principle Specifications

	SH210-6 STD Specifications	SH210LC-6 STD Specifications	
Base	Boom length	5.70 m	
	Arm length	2.94 m	
	Bucket capacity (ISO heaped)	0.8 m <sup>3</sup>	0.9 m <sup>3</sup>
	Std. operating weight	20,100 kg	20,400 kg
Engine	Make & model	ISUZU GI-4HK1X	
	Rated output	117.3 kW (159.5 PS)/1 800 min <sup>-1</sup>	
Hydraulic System	Displacement	5.19 ltr	
	Main pump	2 variable displacement axial piston pumps with regulating system	
	Max pressure	34.3 MPa	
	(with auto power boost)	36.8 MPa	
	Travel motor	Variable displacement axial piston motor	
	Parking brake type	Mechanical disc brake	
Performance	Swing motor	Fixed displacement axial piston motor	
	Travel speed	5.6/3.4 km/h	
	Drawbar pull	188 kN	
	Gradeability	70% <35°>	
	Ground pressure	45 kPa	42 kPa
	Swing speed	11.5 min <sup>-1</sup>	
	Bucket digging force	142 kN	
	/with power boost	152 kN	
Others	Arm digging force	103 kN	
	/with power boost	110 kN	
	Fuel tank	410 ltr	
	Hydraulic fluid tank	147 ltr	

## Working Range

	SH210(LC)-6	
Arm length	2.40 m	2.94 m
Boom length	5.70 m	
A Max digging radius	9 420 mm	9 900 mm
B Max digging depth	6 110 mm	6 650 mm
C Max digging height	9 410 mm	9 610 mm
D Max dumping height	6 590 mm	6 810 mm
E Max vertical wall cut depth	5 500 mm	5 960 mm
F Min front swing radius	3 600 mm	3 600 mm
G Rear end swing radius	2 750 mm	

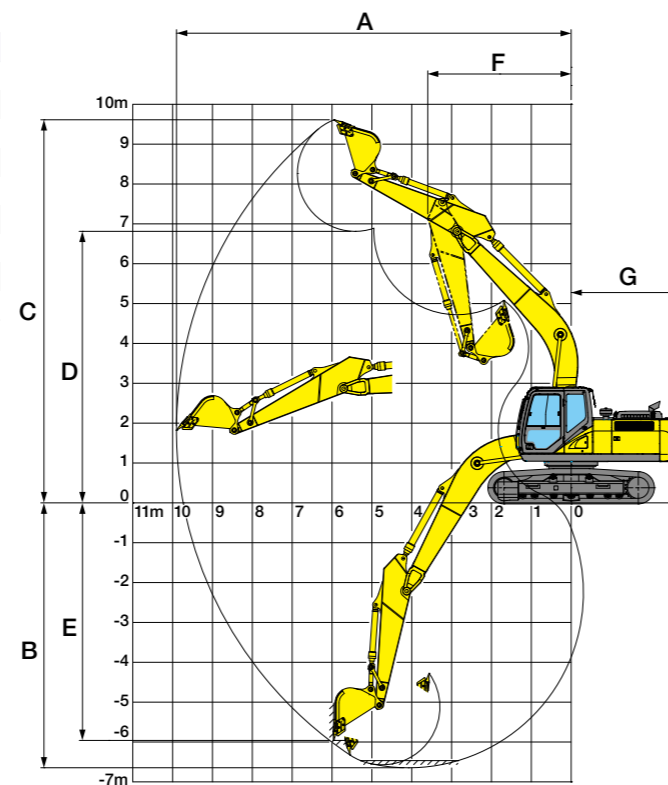

## Standard Equipment

### [Hydraulic system]

- SIH:S+ hydraulic system
- Operation mode (SP, H and A mode)
- Automatic 2-speed travel
- Automatic power boost
- Arm/boom/bucket reactivation circuit
- Automatic swing parking system
- High-performance return filter

### [Cabin/interior equipment]

- Strengthened cabin
- Top guard OPG level 1 (in cab structure)
- Shock-less cab suspension by 4-point fluid mounts
- Built-in type full-colour monitor display
- Tilting console
- Open air introducing pressurised full-automatic air conditioner
- Defroster
- Hot & cool box
- Seat suspension
- Windscreen wiper (with intermittent operation function)
- Cup holder
- AM/FM radio (with muting function and AUX port & USB port)
- Radio mute/ Windscreen wiper one-touch control on joystick
- Clock
- Magazine rack
- Accessory case
- Floor mat
- Armrest & headrest
- Ashtray & cigarette lighter
- Cab light (Auto-OFF function)
- Coat hook

### [Safety equipment]

- Rearview mirror (left/right)
- Emergency escape tool
- Retracting seat belt
- Gate lock lever
- Travel alarm (with on and off switch)
- Anti-theft alarm system
- Engine room firewall
- Fan guard
- Engine emergency stop switch
- Engine neutral start

### [Others]

- Auto/one-touch idling
- Auto idle shutdown system
- EMS
- Long-life hydraulic oil
- Two lights (main unit and left of boom)
- Fuel filter (with water separator)
- Fuel prefilter (with water separator)
- Double-element air cleaner
- Grease-enclosed track link
- Large tool box
- A set of tools

## Accessories (option)

### ■ Cab-top lights



### ■ Rain deflector



### ■ 12V power (DC-DC converter)



### ■ Head guard (OPG level 2)



### ■ Polycarbonate roof top window with sunshade

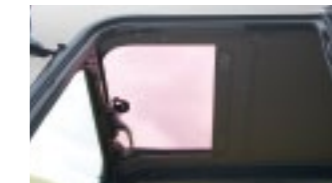

### ■ Front guard (OPG level 1 or 2)



### ■ Front mesh guard (full/lower)



### ■ Precleaner



### ■ Air suspension (KAB seat)



### ■ Refuel pump

### ■ Hose burst check valve (HBCV) for boom/arm cylinders

### ■ Rear view camera

### ■ Side camera

### ■ ROPS Cabin

### ■ ISO compliant mirror

Accessories and specifications may differ depending on countries and regions.

## Dimensions

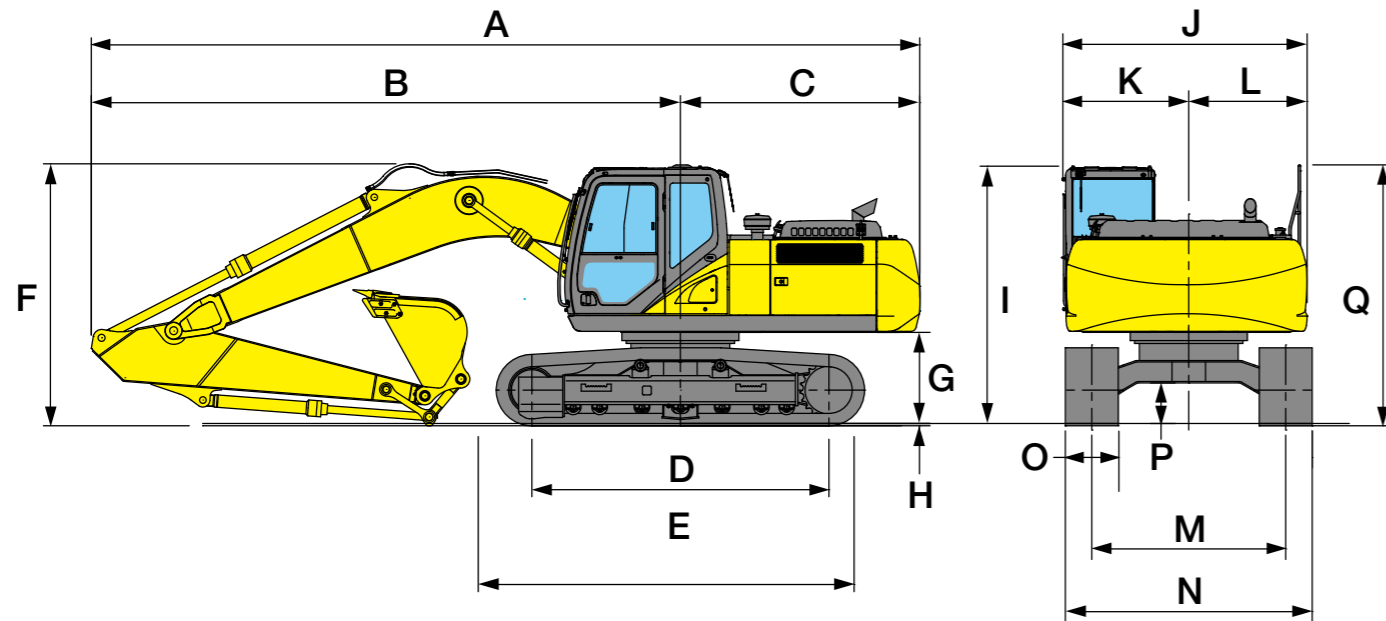

Model	SH210 (LC)-6	
Arm length	2.40 m	2.94 m
A Overall length	9 460 mm	9 400 mm
B Length from centre of machine (to arm top)	6 740 mm	6 680 mm
C Length from centre of machine (to rear end)	2 720 mm	
D Centre to centre of wheels	3 370 (3 360) mm	
E Overall track length	4 180 (4 470) mm	
F Overall height	3 200 mm	2 970 mm
G Clearance height under upper structure	1 040 mm	
H Shoe lug height	26 mm	
I Cab height	2 950 mm	
J Upper structure overall width	2 770 mm	
K Width from centre of machine (left side)	1 430 mm	
L Width from centre of machine (right side)	1 340 mm	
M Track gauge	2 200 (2 390) mm	
N Overall width	2 800 (2 990) mm	
O Std. shoe width	600 mm	
P Minimum ground clearance	440 mm	
Q Handrail height	2 960 mm	

Figure in ( ): LC type

# MEMO